

■ A系列功率电感

A SERIES SMD POWER INDUCTORS

● 特征 FEATURES:

- 超薄 Low profile.
- 屏蔽结构 Magnetic shielded.
- 适合表面贴装 SMT type.



● 应用APPLICATIONS:

- 移动通讯，笔记本电脑； Portable communication equipment, Notebook Computer
- LED电视 LED Television
- DC/DC转换 DC/DC Converters.

● 产品规格型号表示方法HOW TO ORDER:

2213 A - 100 M C
 ① ② ③ ④ ⑤

① 规格尺寸(L×W×T) Dimensions(mm)		② 材质代号 Material Code		③ 感量(μH) Inductance		④ 误差(%) Tolerance		⑤ 应用领域 application area							
2213	22.5×22×12.5	A 合金 Alloy	C 羰基 Carbonyl iron	1R0 1.0	100 10	101 100	102 1000	K 10	L 15	M 20	N 30	C 车载品 For automotive	J 军用品 For military	T 特殊品 For special	无 普通品 Dinary consumer

● 外型尺寸DIMENSIONS:

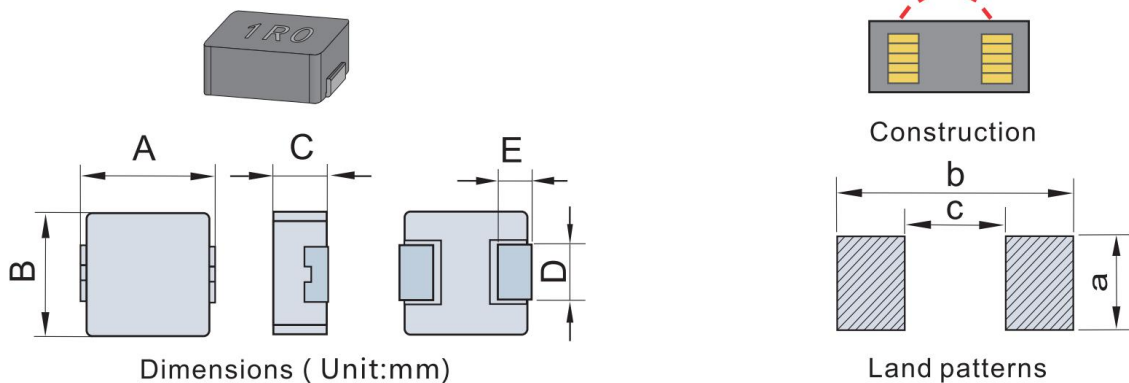

SERIES	A	B	C	D	E	a	b	c
2213A	22.5±0.5	22.0±0.5	12.5±0.5	18.5±0.3	5.0±0.5	19.6Typ	23.3Typ	12.2Typ

● 性能参数 ELECTRICAL CHARACTERISTICS:

规格型号 Part No.	感量 Ls(μ H)	直流电阻 R_{DC} ($m\Omega$)		温升电流 I_{rms} (A)	饱和电流 I_{sat} (A)
		Typ	Max		
FHW2213A-2R2M	2.2	1.2	1.4	48	55
FHW2213A-3R3M	3.3	1.6	2.0	40	45
FHW2213A-4R7M	4.7	2.0	2.5	39	43
FHW2213A-5R6M	5.6	2.5	3.0	38	40
FHW2213A-6R8M	6.8	3.3	3.8	36	36
FHW2213A-8R2M	8.2	4.0	4.8	30	30
FHW2213A-100M	10.0	4.5	5.0	28	28
FHW2213A-150M	15.0	6.8	7.2	23	24
FHW2213A-220M	22.0	9.2	10.6	16	17.5
FHW2213A-330M	33.0	13.5	15.1	15	17
FHW2213A-820M	82.0	36	40	10.2	12

注意Remark :

- 所有测试数据均参考18-25°C环境温度 ;
All test data is referenced to 18-25°C ambient;
- 电感测试条件为用WK3260B或同等设备以100KHz/0.25V测试 ;
Inductance tested at 100KHz/0.25V with WK3260B LCR Meter or equivalent;
- 饱和电流 : 加电流时电感量下降30%左右 ;
 I_{sat} : DC current at which the inductance drops 30% typ from its value without current ;
- 温升电流 : 加电流时产品温度上升40°C左右 ;
 I_{rms} : DC current that causes the temperature rise ($\Delta T = 40^\circ C$ typ) from room temperture;
- 工作温度 (包括自身发热) : -55°C~+ 155°C ;
Operating temperature rang(including coil's self temperature rise) :-55°C~+ 155°C ;

● 包装材料及规格Packaging materials and specifications:

卷轴尺寸图Scroll size:

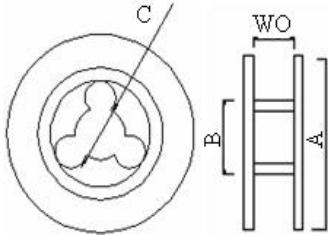

A	B	C	W0	P
330	100	16.5	44.8	32.0

包装带尺寸图Tape size:

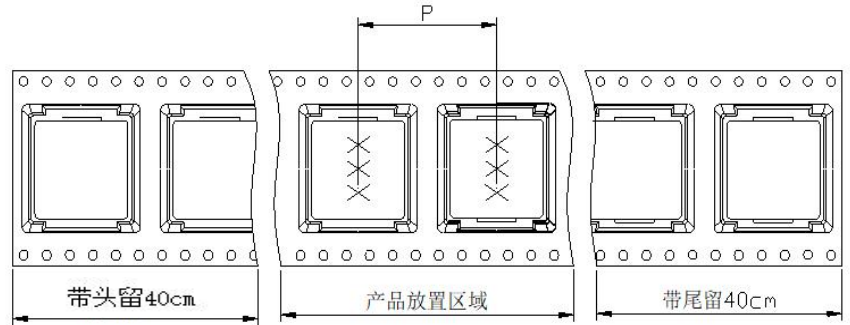

● 包装方式及数量The packing way and quantity :

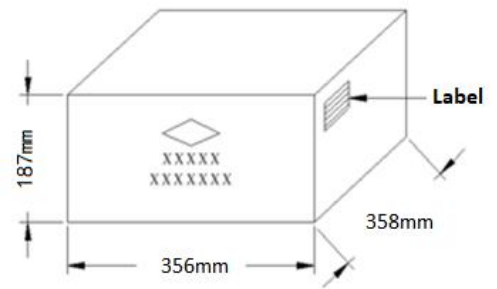
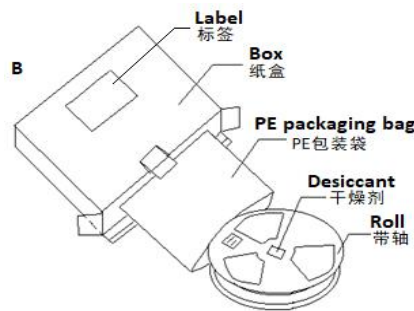
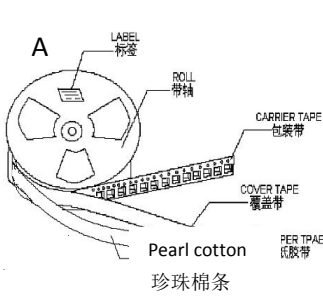

项目 ITEM	卷轴SCROLL	内箱INNER CARTON	外箱OUTER CARTON
		330*100*12mm	345*343*80mm
2213	100 PCS/R	100 PCS/Box	200 PCS/Box

● 剥离强度 Peel strength:

在箭头方向上撕下20克到110克(0.2N到1.1N)的力,剥离速度300mm/MIN以上。

The force tearing off cover 20 to 110 grams (0.2N to 1.1N) in the arrow direction under the following conditions,
The stripping speed is above 300mm/MIN.

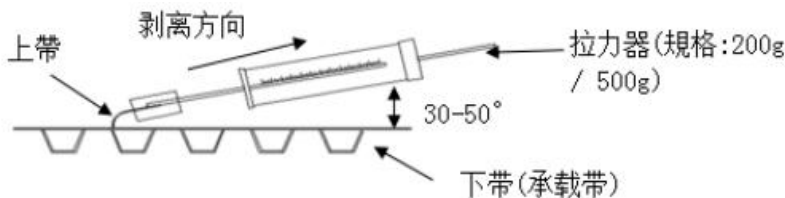

● 内外箱标识内容 Inside and outside box identification content:

Product Label			
客户名称 Customer			
订单号码 P/O			
客户料号 CUST. P/N			
品名 P/N			
数量 QTY		厂商批号 LOT NO.	
检验员 QC		出货日期 DATE	

● 素材清单Material List:

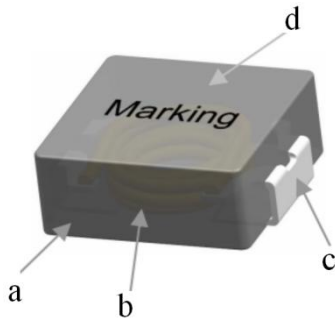

No.	项目ITEM	材料Materials
1	磁芯Core	金属合金Metal alloy
2	线 Wire	漆包线Enameled wire or equivalen
3	端子Terminal	铜+镍+锡Copper+Nickel+Tin
4	油墨Ink	KGK-JET LTH20-Black or equivalen

● 储存条件/注意的事项Storage conditions/Note things:

1. 贮存温度、湿度条件Storage temperature and humidity conditions :

1.1. 产品包装与载体:- 10℃~ + 40℃, 低于60% RH.

Product packing with Carrier tape: -10℃~+40℃ and less than 60% RH.

1.2. 单独的产品:-20℃~ + 60℃, 低于60% RH.

Product alone: -20℃~+60℃ and less than 60% RH.

2. 产品在6个月内使用(注意:产品一经拆开包装,须尽快使用).

Products should be used within 6 months.(Note that the product should be used as soon as possible once it is folded) .

3. 包装材料应保存在空气中不存在氯或硫的地方.

The packaging material should be kept where no chlorine or sulfur exists in the air.

4. 不要用手指触摸电极(焊接端子),因为这可能导致焊接能力的下降.

Do not touch the electrodes (soldering terminals) with fingers as this may lead to deterioration of solder ability.

5. 个别零件强烈建议使用镊子或真空取料机, 散装搬运应减少磨损和机械冲击.

The use of tweezers or vacuum pick-ups is strongly recommended for individual components.Bulk handling should ensure that abrasion and mechanical shock are minimized.